

料号 (P/N)	键位 KEY	颜色 Color	接线规格 wire spec	
FSP840112TW-70UOB1RH	KEY-W	黑色 Black	70MM² 非屏蔽 70MM² un-shield 适配线径范围: φ14.00~φ15.40	
FSP840112TZ-70UOA1RH	KEY-Z	橙色 Orange		
FSP840112TZ-70UOR1RH	KEY-Z	红色 Red		
FSP840112TX-70UOA1RH	KEY-X	橙色 Orange		
FSP840112TY-70UOA1RH	KEY-Y	橙色 Orange		
FSP840112TU-70UOB1RH	KEY-U	黑色 Black		
FSP840112TV-70UOB1RH	KEY-V	黑色 Black		
FSP840112TN-70UOA1RH	KEY-N	黑色 Black		
FSP840112TW-95UOB1RH	KEY-W	黑色 Black		95MM² 非屏蔽 95MM² un-shield 适配线径范围: φ17.50~φ18.50
FSP840112TZ-95UOA1RH	KEY-Z	橙色 Orange		
FSP840112TZ-95UOR1RH	KEY-Z	红色 Red		
FSP840112TX-95UOA1RH	KEY-X	橙色 Orange		
FSP840112TY-95UOA1RH	KEY-Y	橙色 Orange		
FSP840112TU-95UOB1RH	KEY-U	黑色 Black		
FSP840112TV-95UOB1RH	KEY-V	黑色 Black		
FSP840112TN-95UOA1RH	KEY-N	黑色 Black		

键位 (W, Z, N为常用键位)  
KEY (W, Z, N are standing keys)

NOTE:

- 外观表面无划痕、划伤、污渍、异物等缺陷;  
No scratches, scratches, stains, foreign matters and other defects on the appearance surface;
- 产品功能说明参考table 1;  
Refer to table 1 for product function description
- 产品使用PE袋+纸箱包装;  
Products are packed in PE bags + cartons
- 产品符合ROHS;  
Products comply with RoHS

TABLE 1:

项目 Item	规格 SPEC
额定电流 rated current	温升55K MAX: 300A/350A 温升40K MAX: 270A/320A
接线规格 wire spec	70mm²/95mm²
工作电压 Operating voltage	DC1000V
工作温度 Operating temperature	-40°C~+125°C
耐电压 withstand voltage	3000VAC/4800VDC
绝缘电阻 insulation resistance	5000MΩ MIN(干燥 drying) 200MΩ MIN(RH 95%)
盐雾 salt fog	144H (配合状态下 matching state)
防护等级 protection Level	IP54B
插拔寿命 Durability life	500次 500cycling
接触电阻 Contact resistance	0.3 mΩ max

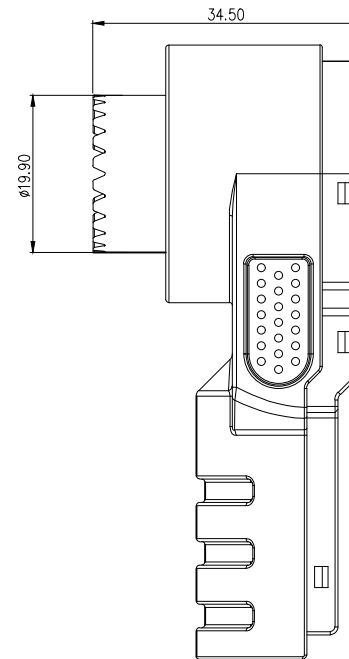
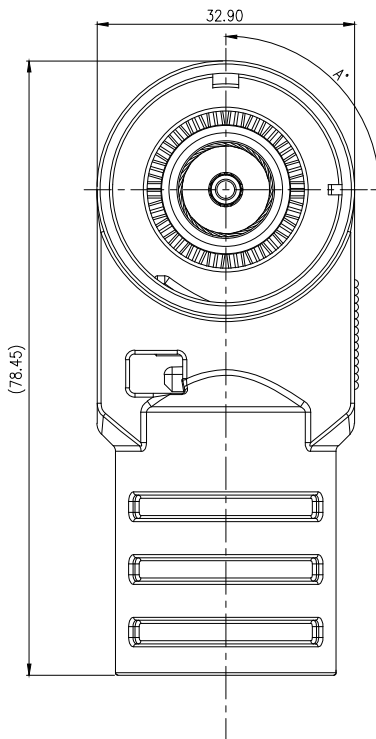

键位 (A°)	KEY (A°)
90°	KEY-W
180°	KEY-X
247°	KEY-Y
293°	KEY-Z
67°	KEY-U
113°	KEY-V
无键位	KEY-N

REVISIONS					
REV	ECN NO	DESCRIPTION	DATE	BY	APPR
A1	--	RELEASE DRAWING	2020.12.03	ABLE	BENSON
A2	--	定义线径范围	22.09.21	Devin	BENSON

ITEM	PART NUMBER	Qty	DESCRIPTION	REMARK
<b>MATERIALS LIST</b>				
UNLESS OTHERWISE SPECIFIED 1) All dimensions are in metric (mm). 2) Tolerances are as follows: 1 PL DEC ±1.00 2 PL DEC ±0.50 Fractions ±1/64 3 PL DEC ±0.25 Angles ±2°		MATERIAL SPECIFICATIONS: SEE TABLE		www.metabee.com
DRAWING TYPE CUSTOMER DRAWING		METABEE LIMITED		
SIGNATURE Devin		DATE 22.09.21		12.0单芯弯头连接器插头
PART NO: FSP840112T*_*U*1RH		THIRD ANGLE PROJECTION 文件编号 FSCM NO. 幅面 SIZE 质量 MASS 版次 REV. 比例 SCALE A4 9 A2 1:1		
SHEET 1 OF 2		DWG NO: S-FSP840112H-1101RH		

REVISIONS					
REV	ECN NO	DESCRIPTION	DATE	BY	APPR
A1	--	RELEASE DRAWING	2020.12.03	ABLE	BENSON
A2	--	定义线径范围	22.09.21	Devin	BENSON

辅件说明 Accessory description

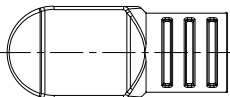
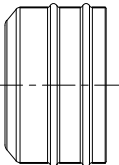
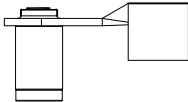
品名 Part name	外形 Appearance	线束规格 Wire Spec	颜色 Color	料号 P/N	用量 Quantity
插头后盖 Back cover		70~95 MM² 非屏蔽线 70~95MM² un-shield	黑色 Black	F1-P10202-0B	1PCS
			橙色 Orange	F1-P10202-0A	
			红色 Red	F1-P10202-0R	
护套 sheath		70MM² 非屏蔽线 70MM² un-shield 95MM² 非屏蔽线 95MM² un-shield 70MM² 非屏蔽线 70MM² un-shield 95MM² 非屏蔽线 95MM² un-shield 70MM² 非屏蔽线 70MM² un-shield 95MM² 非屏蔽线 95MM² un-shield	黑色 Black	F2-R10108-0B	1PCS
			橙色 Orange	F2-R10109-0B	
			黑色 Black	F2-R10108-0A	
			橙色 Orange	F2-R10109-0A	
			红色 Red	F2-R10108-0R	
			红色 Red	F2-R10109-0R	
端子 terminal		70~95 MM² 非屏蔽线 70~95MM² un-shield		F3-C10097-24	1PCS

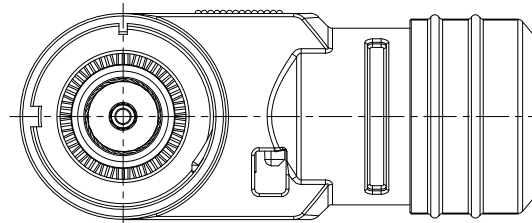
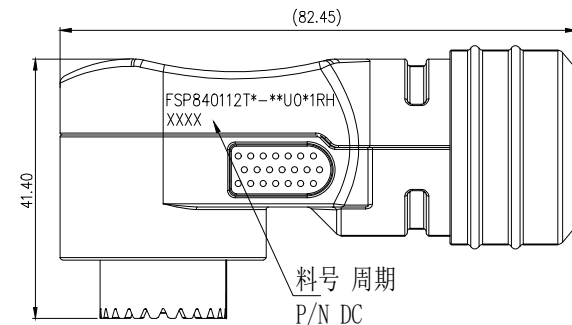

ITEM	PART NUMBER	Qty	DESCRIPTION	REMARK
<b>MATERIALS LIST</b>				
UNLESS OTHERWISE SPECIFIED 1) All dimensions are in metric(mm). 2) Tolerances are as follows: 1 PL DEC ±1.00 2 PL DEC ±0.50 Fractions ±1/64 3 PL DEC ±0.25 Angles ±2°		MATERIAL SPECIFICATIONS: SEE TABLE		www.metabee.com
SIGNATURE Devin		DATE 22.09.21	DRAWING TYPE CUSTOMER DRAWING	METABEE LIMITED
CHECKED				12.0单芯弯头连接器插头
ENGINEER				PART NO: FSP840112T*-**U0*1RH
APPROVAL				第三角投影 THIRD ANGLE PROJECTION
CUSTOMER				文件编号 FSCM NO. A4
				幅面 SIZE A4
				质量 MASS 9
				版次 REV. A2
				比例 SCALE 1:1
				SHEET 2 OF 2
				DWG NO: S-FSP840112T*-**U0*1RH

