

REVISIONS					
REV	ECN NO	DESCRIPTION	DATE	BY	APPR
A1	--	RELEASE DRAWING	2020.07.27	ABLE	BENSON

料号 (P/N)	键位 KEY	颜色Color	接线规格 wire spec
FSP840114CW-120U0B1	KEY-W	黑色Black	120MM² 非屏蔽 120MM² un-shield
FSP840114CZ-120U0A1	KEY-Z	橙色Orange	
FSP840114CX-120U0A1	KEY-X	橙色Orange	
FSP840114CY-120U0A1	KEY-Y	橙色Orange	
FSP840114CU-120U0B1	KEY-U	黑色Black	
FSP840114CV-120U0B1	KEY-V	黑色Black	150MM² 非屏蔽 150MM² un-shield
FSP840114CN-120U0A1	KEY-N	橙色Orange	
FSP840114CN-120U0B1	KEY-N	黑色Black	
FSP840114CW-150U0B1	KEY-W	黑色Black	
FSP840114CZ-150U0A1	KEY-Z	橙色Orange	
FSP840114CX-150U0A1	KEY-X	橙色Orange	150MM² 非屏蔽 150MM² un-shield
FSP840114CY-150U0A1	KEY-Y	橙色Orange	
FSP840114CU-150U0B1	KEY-U	黑色Black	
FSP840114CV-150U0B1	KEY-V	黑色Black	
FSP840114CN-150U0A1	KEY-N	橙色Orange	
FSP840114CN-150U0B1	KEY-N	黑色Black	

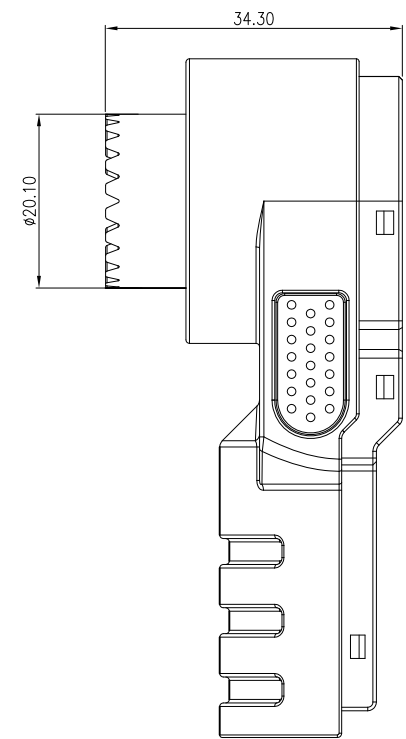
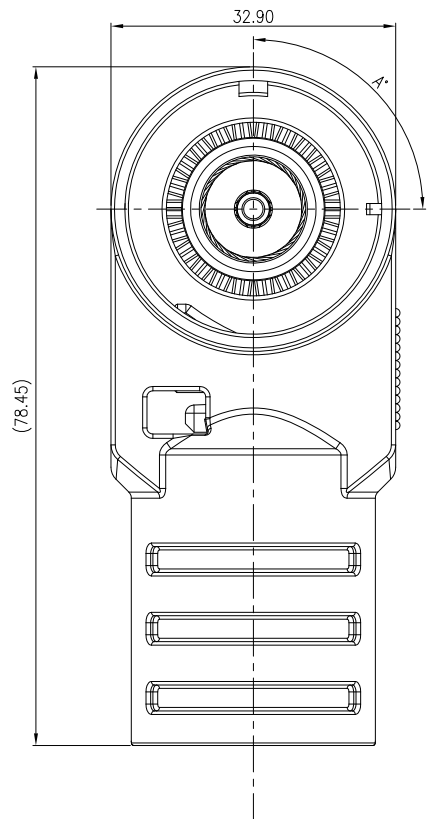

键位 (A°) KEY (A°)	90°	KEY-W
	180°	KEY-X
	247°	KEY-Y
	293°	KEY-Z
	67°	KEY-U
	113°	KEY-V
	无键位	KEY-N

键位 (W, Z, N为常用键位)
KEY (W, Z, N are standing keys)

- NOTE:
- 外观表面无划痕、划伤、污渍、异物等缺陷;
No scratches, scratches, stains, foreign matters and other defects on the appearance surface;
 - 产品功能说明参考table 1;
Refer to table 1 for product function description
 - 产品使用PE袋+纸箱包装;
Products are packed in PE bags + cartons
 - 产品符合ROHS;
Products comply with RoHS

TABLE 1:

项目 Item	规格 SPEC
额定电流 rated current	400A/500A
接线规格 wire spec	120mm²/150mm²
工作电压 Operating voltage	DC1500V
工作温度 Operating temperature	-40°C~+125°C
耐电压 withstand voltage	4000V AC
绝缘电阻 insulation resistance	5000MΩ MIN(干燥 drying) 200MΩ MIN(RH 95%)
盐雾 salt fog	144H (配合状态下 matching state)
防护等级 protection Level	IP54B
插拔寿命 Durability life	500次 500cycling
接触电阻 Contact resistance	0.3 mΩ max

ITEM	PART NUMBER	Qty	DESCRIPTION	REMARK
MATERIALS LIST				
UNLESS OTHERWISE SPECIFIED 1) All dimensions are in metric(mm). 2) Tolerances are as follows: 1 PL DEC ±1.00 2 PL DEC ±0.50 Fractions ±1/64 3 PL DEC ±0.25 Angles ±2°			MATERIAL SPECIFICATIONS: SEE TABLE	www.metabee.com METABEE LIMITED
签名 SIGNATURE			日期 DATE	DRAWING TYPE CUSTOMER DRAWING
制图 DRAWN		ABLE	2020.07.27	PART NO: FSP840114C*-**U0*1
审核 CHECKED				第三角投影 THIRD ANGLE PROJECTION
工艺 ENGINEER				文件编号 FSCM NO.
批准 APPROVAL				幅面 SIZE
客户 CUSTOMER				质量 MASS
				版次 REV.
				比例 SCALE
				14.0单芯弯头连接器插头
				A4 9 A3 1:1
				SHEET 1 OF 2
				DWG NO: S-FSP840114C*-M10*1



REVISIONS					
REV	ECN NO	DESCRIPTION	DATE	BY	APPR
A1	--	RELEASE DRAWING	2020.07.27	ABLE	BENSON

辅件说明Accessory description

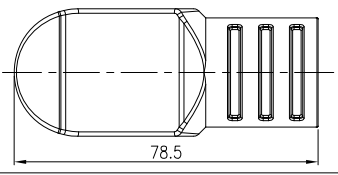
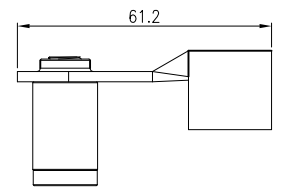
品名Part name	外形 Appearance	线束规格Wire Spec	颜色Color	料号 P/N	用量Quantity
插头后盖 Back cover		120~150 MM² 非屏蔽线 120~150MM² un-shield	黑色Black	F1-P10202-0B	1PCS
			橙色Orange	F1-P10202-0A	
端子 terminal		120MM² 非屏蔽线 150MM² un-shield		F5-C10158-01	1PCS
				150MM² 非屏蔽线 150MM² un-shield	

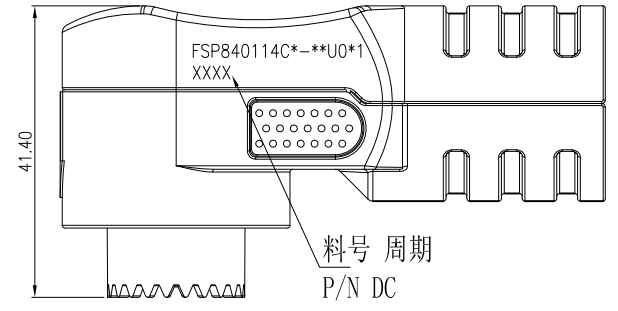
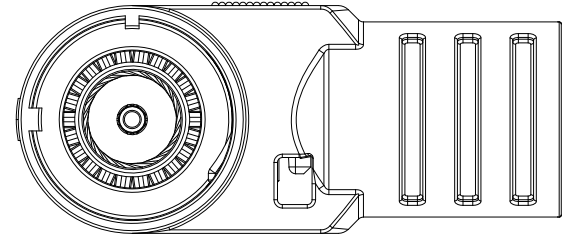

ITEM	PART NUMBER	Qty	DESCRIPTION	REMARK
MATERIALS LIST				
UNLESS OTHERWISE SPECIFIED 1) All dimensions are in metric(mm). 2) Tolerances are as follows: 1 PL DEC ±1.00 2 PL DEC ±0.50 Fractions ±1/64 3 PL DEC ±0.25 Angles ±2°			MATERIAL SPECIFICATIONS: SEE TABLE	www.metabee.com
签名 SIGNATURE 制图 DRAWN: ABLE 审核 CHECKED: 工艺 ENGINEER: 批准 APPROVAL: 客户 CUSTOMER:			DRAWING TYPE CUSTOMER DRAWING	METABEE LIMITED
日期 DATE: 2020.07.27				14.0单芯弯头连接器插头 PART NO: FSP840114C*--**U0*1
				第三角投影 THIRD ANGLE PROJECTION