

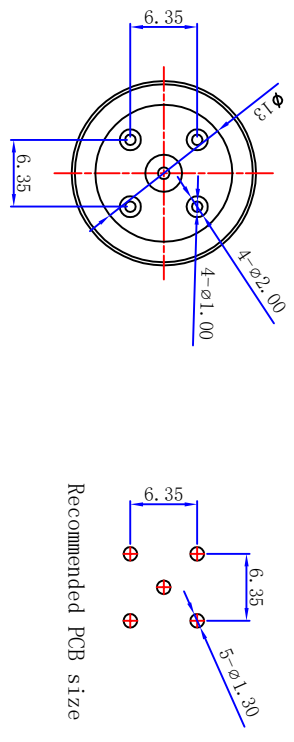

Product NO.		RHT-610-0225	
REV	DESCRIPTION	DWN	DATE
R1.0	First issue	Mr. Wang	2017/02/23
R2.0	Increase electrical parameters, detailed dimensions	Gavin	2020/12/17
			APPROVEN
			JIM.KING
			JIM.KING

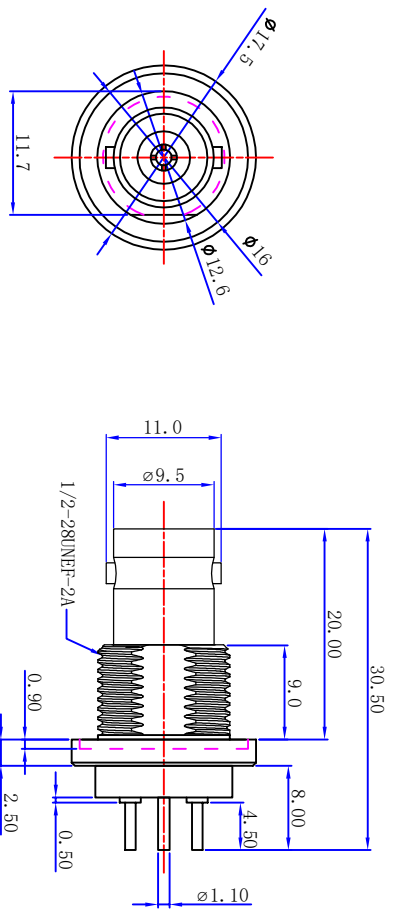

Recommended PCB size

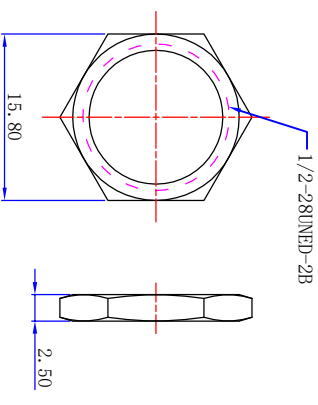
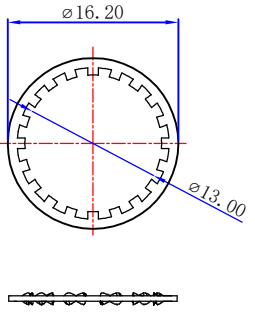
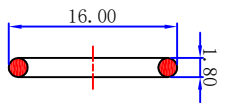
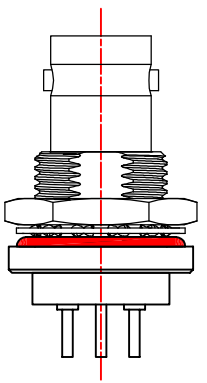
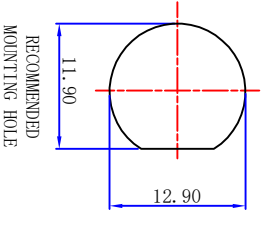

Specifications
 Impedance: 50 Ohms
 Frequency Range: DC~6G
 VSWR: 1.5MAX
 Working Voltage: 500V rms @ sea level
 Insulation Resistance: 5000 MOhms min
 Temperature Range: -55°C TO +165°C

NO	DESCRIPTION	MATERIAL	FINISH	QTY
1	Booy	Brass	Nickel	1
2	Insulator	PTFE	NONE	1
3	PIN	Brass	Gold	1
4	O-Ring	Rubber	Red	1
5	Washer	Iron	Nickel	1
6	Nut	Brass	Nickel	1

-TOLERANCES- UNLESS OTHERWISE SPECIFIED				PART DESCRIPTION: BNC Jack PCB Mount Bulkhead	
UNLESS OTHERWISE SPECIFIED TOLERANCES FOR MILLIMETERS ARE: 0.5 - 8mm ± 0.20mm 8 - 30mm ± 0.25mm 30 - 120mm ± 0.30mm				<h1>RENHOTEC GROUP</h1>	
Appd:	JIM.KING	P/N:	RHT-610-0225	Date	2020.12.17
Check:		Draw:	Gavin	Scale	Free
			Unit	MM	
			Type	Z	
			Page	1/1	