

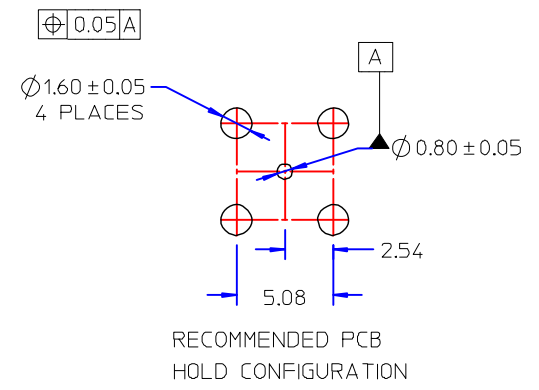

Product NO.		DOSIN-807-0011		
REV	DESCRIPTION	DWN	DATE	APPROVEN
A	First issue	JIM	2012/11/02	John kine

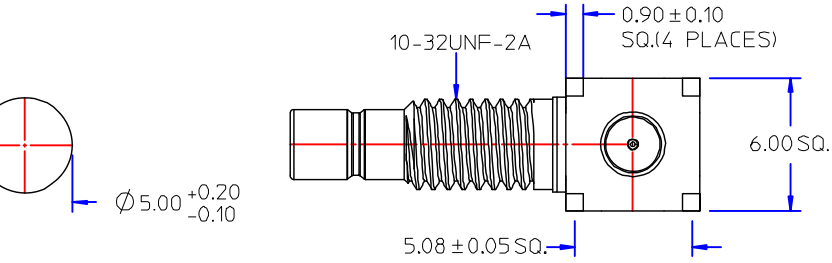
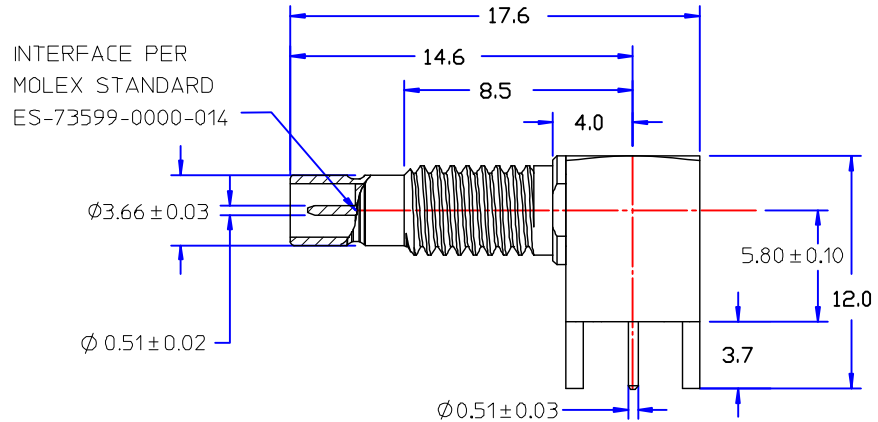
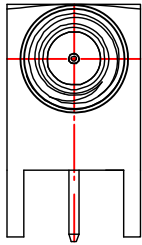

MATERIALS AND FINISHES
 CONNECTOR BODY BRASS
 PLATED GOLD

CENTER CONTACT PHOSPHOR BRONZE
 PLATED GOLD

DIELECTRIC TEFLON

HEX. NUT BRASS
 PLATED GOLD

LOCK WASHER PHOSPHOR BRONZE
 PLATED GOLD

WASHER BRASS
 PLATED GOLD

PACKAGING
 PLASTIC TRAYS

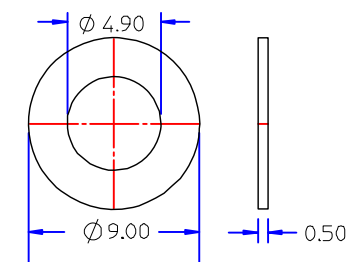
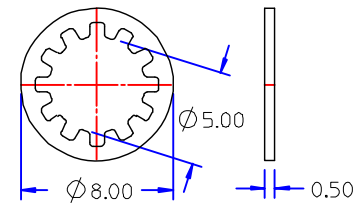
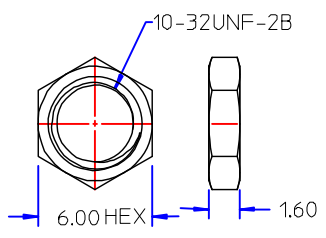
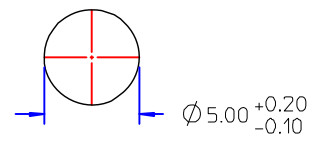

NOTE:		Tolerance	0-6 ±0.10 6-30 ±0.20 30-120 ±0.40 Angular ±1°
DRAWN	2012/11/10	View	
CHECKED		UNIT	MM
APPROVALS	12/04.2012	SCALE	1:1
John Kine			

Dosin Industrial(H.K)Co.Ltd 东莞市德索五金电子制品有限公司 Dosin Hardware Electronics Co.,Ltd		E-mail:dosin2005@163.com dosin2005@dosin-china.com Web:http://www.dosinconn.com TEL:(0086)769-81153906 FAX:(0086)769-81875836	
Name:		SMB R/A JACK PCB CONNECTOR	
SIZE A	Product NO.	REV	
	DOSIN-807-0011	A	
DateTime	CAD FILE	SHEET: 1 OF 1	
2012/11/02	D/company drawings/BD		

3	INSULATOR	PTFE	NATURAL	1
2	CONTACT PIN	BRASS	GOLD	1
1	BODY	BRASS	NICKEL	1
NO	DESCRIPTION	MATERIAL	FINISH	QTY