

箱体内连接方式 Connection mode in box body

推荐装置板

Recommended Assembly Board

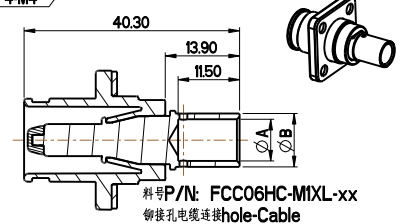
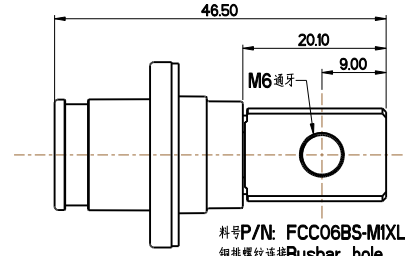
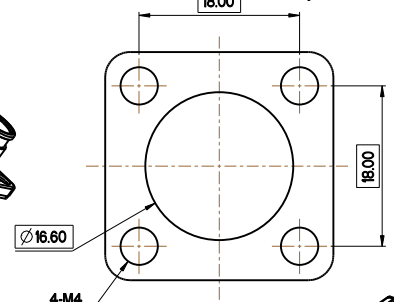
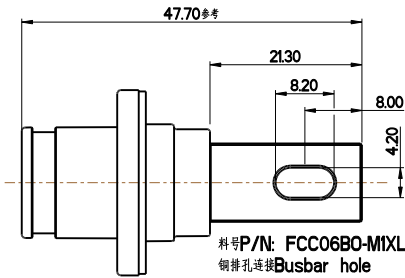
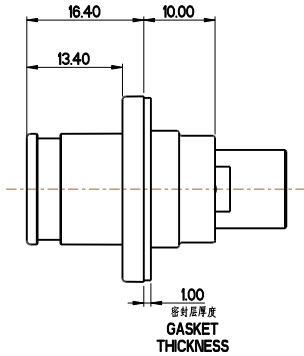
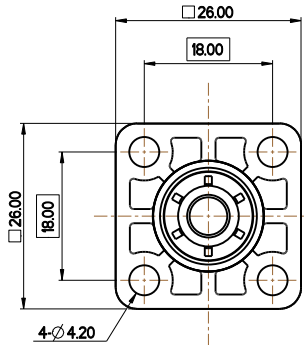

FCC06BO - MiXL - NWF - 1700

流水号
Serial Number

N: 非屏蔽 Non-shielding
W: 防水 IP67 (匹配状态) Waterproof IP67 (Mated)
F: 法兰安装 Flange Installation

M: 插针 Male Contact
1: 1芯 1pin
x: R红色 Red / B黑色 Black / Y橘黄色 Yellow
L: 直角类型 Straight Type
R: 弯角类型 R-Angle Type

06: Pin ø 6.00mm 插针 ø 6.00mm
BO: 铜排孔连接 Busbar hole
SO: 外螺纹连接 Outer Screw
SI: 内螺纹连接 Inner Screw

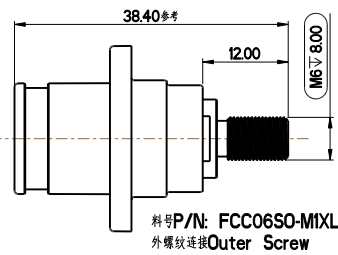
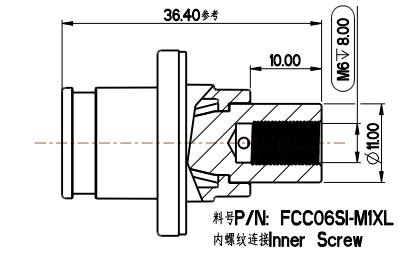

料号 P/N	电缆截面面积 mm ² Cable zero	额定电流 A Rated Current	A	B
FCC06HC-MiXL-10	10.00	60	5.00	7.00
FCC06HC-MiXL-16	16.00	100	6.20	8.15
FCC06HC-MiXL-25	25.00	120	7.80	10.00

尺寸范围 Dim Range	公差 Tolerance
0.00 - 100	±0.05
100 - 30.00	±0.10
30.00 - 50.00	±0.20
50.00 - 80.00	±0.35
80.00 - X	±0.50
X	±0.50°

机械及环境特性		电气性能	
Mechanical & Environment	Characteristic	Electric	Characteristic
工作温度 Working Temp.	-40 - 125° C	额定电流 Rated Current	120A
插接寿命 Durability	>3000次 Cycles	额定电压 Rated Voltage	1000Vac
公称绝缘力 M&F holding F	>200N	绝缘耐压 Dielectric Strength	3000VDC (Min.)
阻燃等级 Flame retardant grade	UL94-V0	温升 Temperature Rise	20° C @ 2hrs

订单料号 Order P/N	产品描述 Production Desc.
FCC06xx-MiXL	ø 6.00mm 1Pin Connector, Plug ø 6.00mm 单芯连接器插座

1	FCC06xx-MiXL-NWN-1706	插座壳体 Plug Shell	尼龙 PA	1	NA 无
2	FCC06xx-MiXL-NWN-1707	手指保护 Finger Protection	尼龙 PA	1	NA 无
3	P0600-0483-xx1	插针 Pin	T2 红铜	1	镀银 Ag
4	R-MTL-0149	方形密封垫 Square Gasket	氟丁橡胶 CR	1	选配件 Optional Part
项次 Items	料号 P/N	名称 Name	材料 Material	用量 Qty	表面处理 Surface

备注 Note: 没有特别注明按如下标准 No define
1 带环的尺寸必须保证 Ringed dimensions must be assure
2 表面不得有毛刺 No burr

SOP / SIP Number :		Material:	
Drawn		See Table 见表	
Checked			
QA			
Approvals	Sign	Date	Dimensions in: mm



Page Sheet: 1/1	
Title	
ø 6.00mm 单芯插座 ø 6.00mm Single Plug	
Dwg No.	FCC06xx-MiXL-NWN-1700
Iss/rev	B

Rev	DCN/ECN or Description	Date